

**SAN-EI**

# *San-Ei*

**AIR WINCHES**

**Built To Last Since 1936**

*Call Today to Order • 800-521-8104*

## San-Ei Air Winches

San-Ei has been manufacturing world-class air winches for more than 75 years. Michigan Pneumatic Tool has been the exclusive importer of San-Ei air winches to the Americas for more than 50 years. Experience the unprecedented quality of San-Ei air winches in your rental fleet. Capacity ranges from 1100 lbs to 22,000 lbs to suit your needs.

Options and features include: short or long drum, manual or automatic brake, pendant controls, drum guards, exhaust mufflers, filter/lubricator kits, support cages and MPT's training, support and service.

### Model Identification

| Prefix        | Capacity   | Motor                            | Drum   | Control  | Internal Disk Brake                       | Clutch   | External Brake (MP-W series only)       | Guard                      | Support Cage (MP-W series only)     | Filter   |
|---------------|--|----------------------------------|--|--|---|--|---|----------------------------|-------------------------------------|--|
| MP-W or MP-AH | 05, 0.5 t<br>10, 1.0 t<br>20, 2.0 t<br>30, 3.0 t<br>50, 5.0 t<br>100, 10.0 t<br>45, 11.0 t | 3, DM3<br>220, DM220<br>36, DM36 | S, Short Drum<br>S1, Standard Drum<br>(Standard Drum only available on MP-AH Series)<br>L, Long Drum | A, Manual Control Throttle (MP-W Series only)<br>Self-closing: shuts off automatically when released.<br>P, Pendant Control Throttle | H, Internal Disk Brake<br>***,<br>No Code | C, Clutch (Manual Brake Only)<br>*,<br>No Code | AB, Automatic Brake<br>MB, Manual Brake | G, Guard<br>**,<br>No Code | F, Support Cage<br>****,<br>No Code | S14590, Filter/Lubricator Kit<br>*****,<br>No Code |

\* Without Clutch  
\*\* Without Drum Guard  
\*\*\* Single Drum Brake  
\*\*\*\* Without Support Cage  
\*\*\*\*\* Without Filter / Lubricator Kit

### Specifications

| Motor Series | Drum     | Motor Output | Capacity   | Line Speed at Capacity | Cable Capacity                  | Weight w/o Rope Manual Brake | Weight w/o Rope Auto Brake | Avg. Air Consumption |
|--------------|----------|--------------|------------|------------------------|---------------------------------|------------------------------|----------------------------|----------------------|
| MP-W05AA3    | Short    | 2.3 hp       | 1100 lbs   | 62 ft/min              | 5/16" x 145 ft<br>1/4" x 240 ft | 97 lbs                       | 104 lbs                    | 71 cfm               |
| MP-W10220    | Short    | 9.6 hp       | 2200 lbs   | 121 ft/min             | 1/2" x 375 ft                   | 566 lbs                      | 588 lbs                    | 191 cfm              |
|              | Long     |              |            |                        | 1/2" x 750 ft                   | 608 lbs                      | 635 lbs                    |                      |
| MP-W20220    | Short    | 9.6 hp       | 4400 lbs   | 62 ft/min              | 1/2" x 375 ft<br>7/16" x 475 ft | 586 lbs                      | 608 lbs                    | 191 cfm              |
|              | Long     |              |            |                        | 1/2" x 750 ft<br>7/16" x 950 ft | 632 lbs                      | 654 lbs                    |                      |
| MP-W3036     | Short    | 16.0 hp      | 6600 lbs   | 62 ft/min              | 5/8" x 525 ft                   | 1035 lbs                     | 1066 lbs                   | 318 cfm              |
|              | Long     |              |            |                        | 5/8" x 1050 ft                  | 1130 lbs                     | 1161 lbs                   |                      |
| MP-W5036     | Short    | 16.0 hp      | 11,000 lbs | 36 ft/min              | 7/8" x 375 ft<br>3/4" x 500 ft  | 1670 lbs                     | 1716 lbs                   | 318 cfm              |
|              | Long     |              |            |                        | 7/8" x 750 ft<br>3/4" x 1000 ft | 1890 lbs                     | 1923 lbs                   |                      |
| MP-AH45      | Standard | 23.0 hp      | 22,000 lbs | 27 ft/min              | 1-1/4" x 853 ft                 | N/A                          | 3375 lbs                   | 600 cfm              |

Figures are shown with supplied air pressure at 90 psi. Capacities rated at half drum.

All San-Ei air winches feature a marine-grade paint specifically designed for use in seaport applications and other harsh environments. With threaded exhaust ports, you can also use the San-Ei air winches indoors and divert the exhaust to the exterior or away from hazardous materials or gases.

## MP-W05AA3 Series

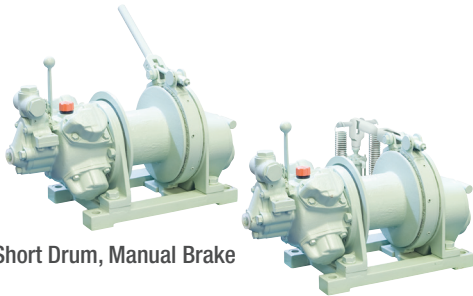

Short Drum, Manual Brake

Short Drum, Auto Brake

## MP-W10220 Series

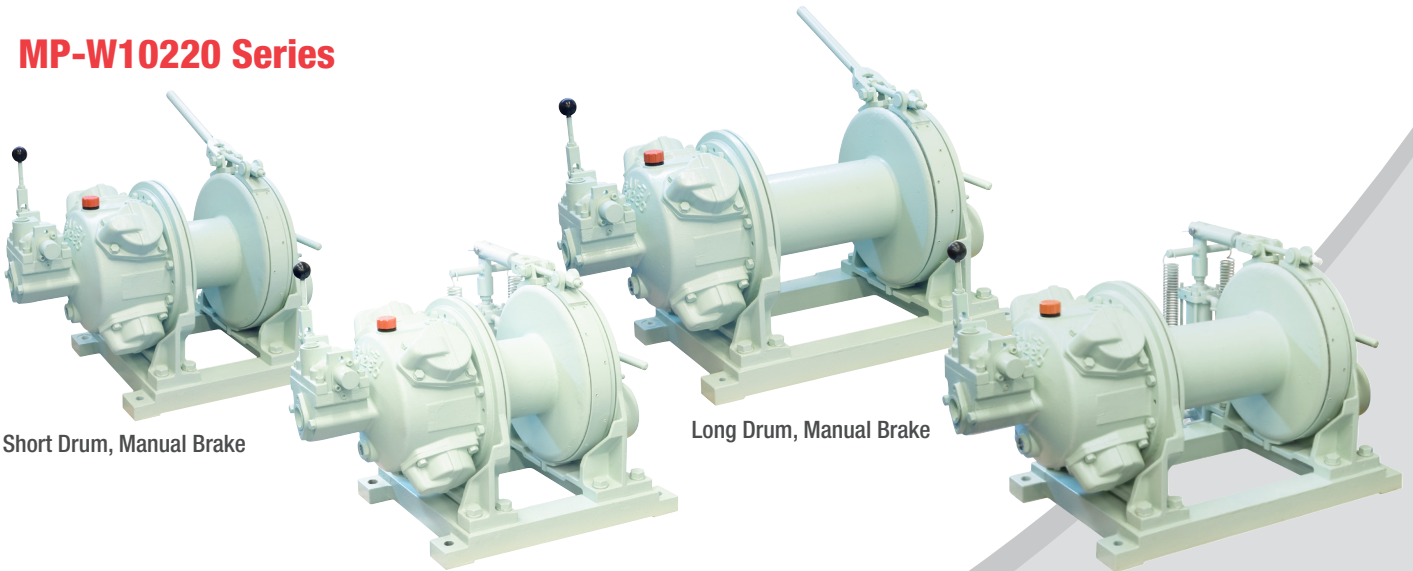

Short Drum, Manual Brake

Short Drum, Auto Brake

Long Drum, Manual Brake

Long Drum, Auto Brake

## MP-W20220 Series

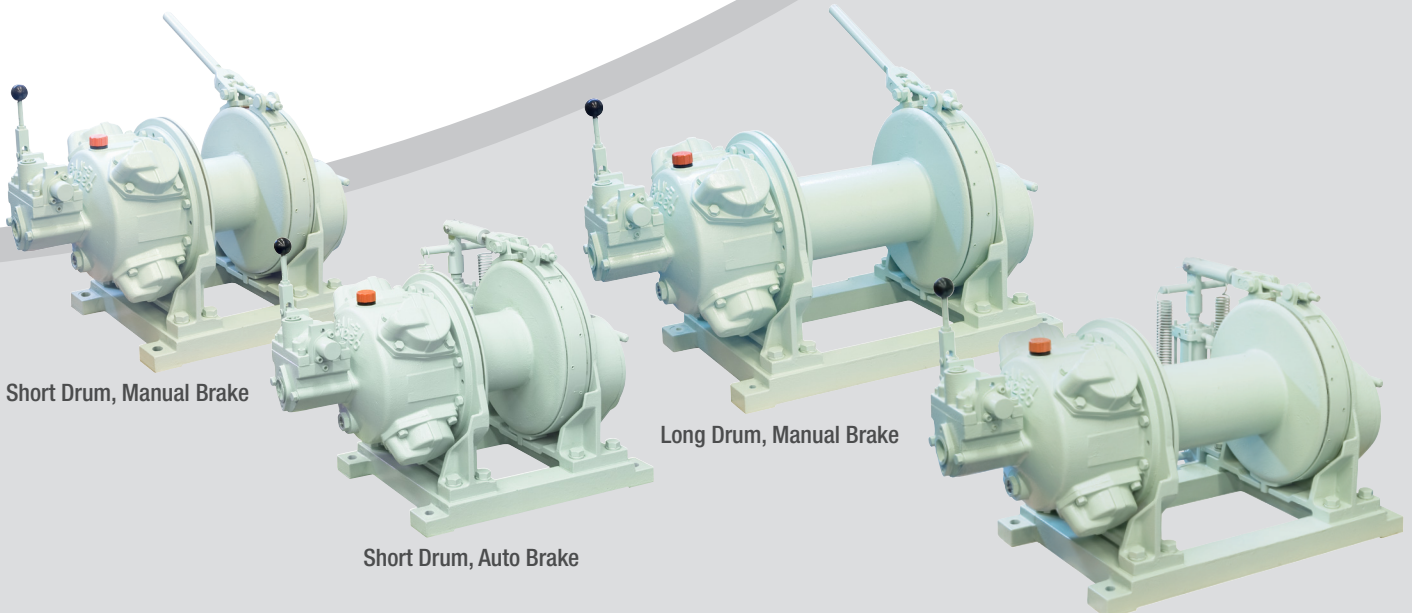

Short Drum, Manual Brake

Short Drum, Auto Brake

Long Drum, Manual Brake

Long Drum, Auto Brake



## MP-W3036 Series

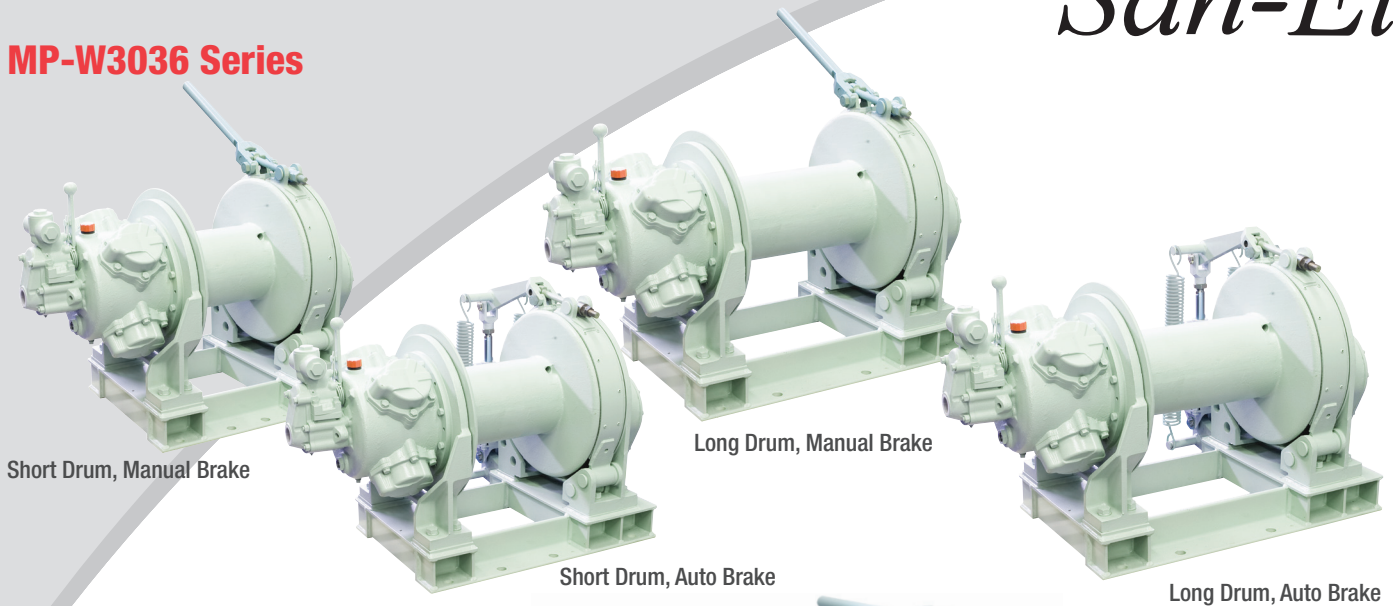

Short Drum, Manual Brake

Long Drum, Manual Brake

Short Drum, Auto Brake

Long Drum, Auto Brake

## MP-W5036 Series

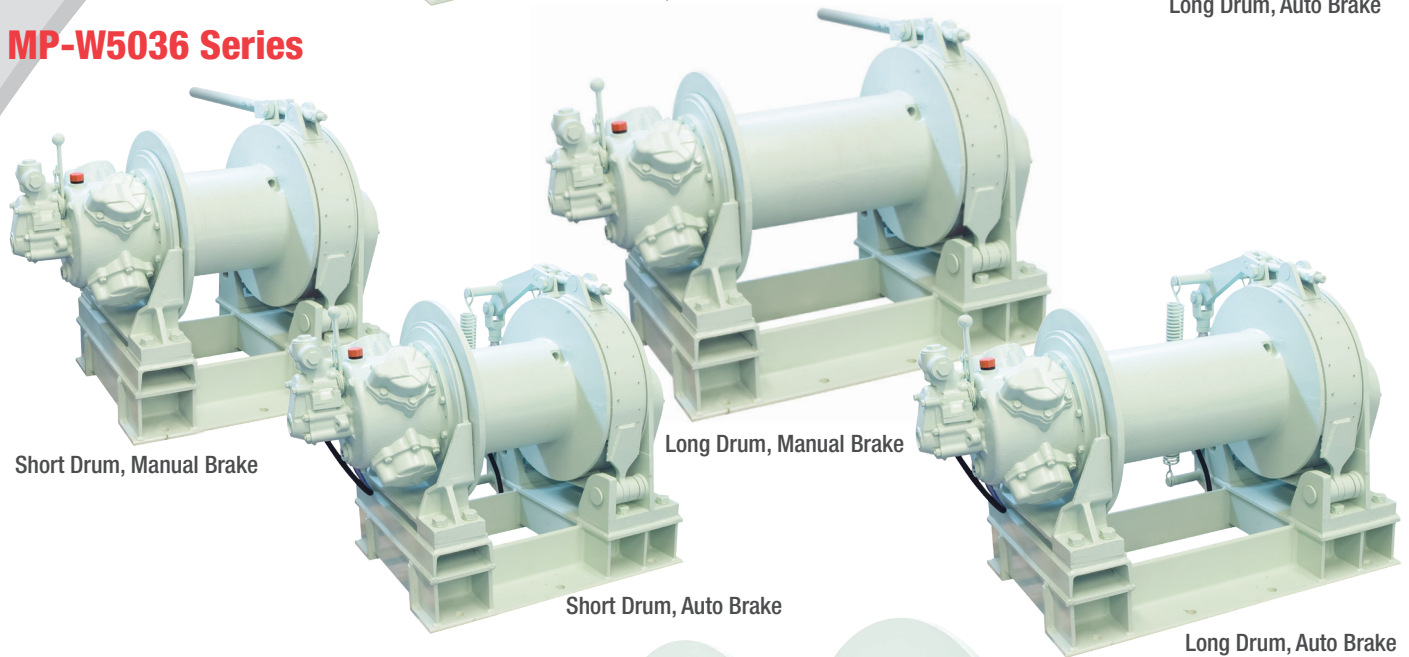

Short Drum, Manual Brake

Long Drum, Manual Brake

Short Drum, Auto Brake

Long Drum, Auto Brake

## MP-AH45 Series

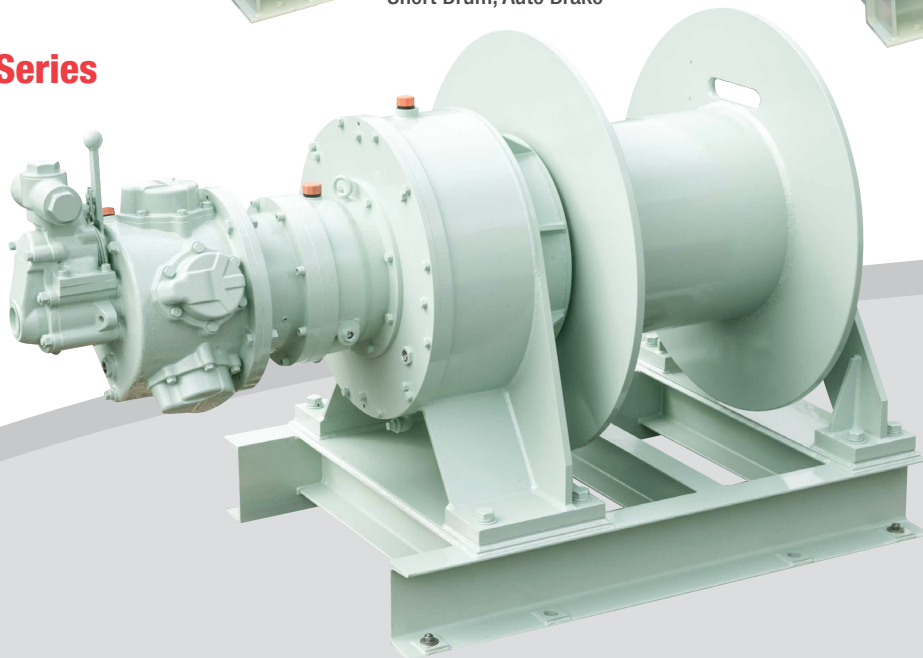

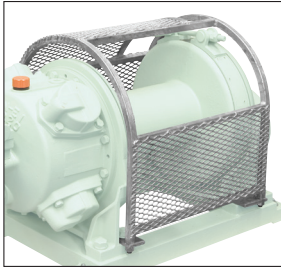

**MP-W20220SPAB**  
Air Winch w/Pendant

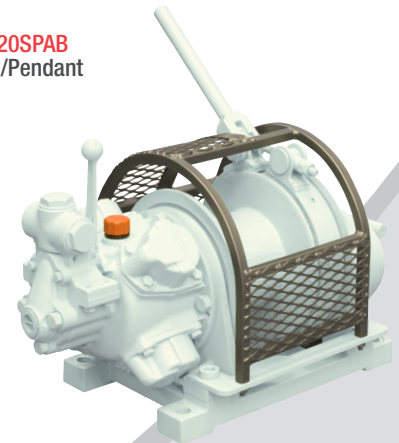

**MP-W05AA3SACMBG**  
Air Winch w/Guard

## Drum Guards

| Part             | Drum     | Fits Tool Model                        |
|------------------|----------|--|
| <b>E302-104G</b> | Short    | MP-W05 Series                          |
| <b>E398-001G</b> | Short    | MP-W10220S Series<br>MP-W20220S Series |
| <b>E398-003G</b> | Long     | MP-W10220L Series<br>MP-W20220L Series |
| <b>E398-005G</b> | Short    | MP-W3036S Series                       |
| <b>E398-007G</b> | Long     | MP-W3036L Series                       |
| <b>E305-011G</b> | Short    | MP-W5036S Series                       |
| <b>E305-013G</b> | Long     | MP-W5036L Series                       |
| <b>E305-015G</b> | Standard | MP-AH45-100-S1H Series                 |

**NOTICE:** Do not lift air winches by guards.  
Guards were designed to prevent entanglement.

## Complete Model Reference

| Model Description  | Standard Model   | Model w/ Pendant                         | Model w/ Guard   | Model w/ Pendant & Guard                   |
|--|--|--|--|--|
| 1100 lbs, Short Drum, Manual Brake<br>1100 lbs, Short Drum, Auto Brake   | MP-W05AA3SACMB<br>MP-W05AA3SAAB                                    | —<br>MP-W05AA3SPAB                       | MP-W05AA3SACMBG<br>MP-W05AA3SAABG                                      | —<br>MP-W05AA3SPABG                        |
| 2200 lbs, Short Drum, Manual Brake<br>2200 lbs, Short Drum, Auto Brake<br>2200 lbs, Long Drum, Manual Brake<br>2200 lbs, Long Drum, Auto Brake         | MP-W10220SACMB<br>MP-W10220SAAB<br>MP-W10220LACMB<br>MP-W10220LAAB | —<br>MP-W10220SPAB<br>—<br>MP-W10220LPAB | MP-W10220SACMBG<br>MP-W10220SAABG<br>MP-W10220LACMBG<br>MP-W10220LAABG | —<br>MP-W10220SPABG<br>—<br>MP-W10220LPABG |
| 4400 lbs, Short Drum, Manual Brake<br>4400 lbs, Short Drum, Auto Brake<br>4400 lbs, Long Drum, Manual Brake<br>4400 lbs, Long Drum, Auto Brake         | MP-W20220SACMB<br>MP-W20220SAAB<br>MP-W20220LACMB<br>MP-W20220LAAB | —<br>MP-W20220SPAB<br>—<br>MP-W20220LPAB | MP-W20220SACMBG<br>MP-W20220SAABG<br>MP-W20220LACMBG<br>MP-W20220LAABG | —<br>MP-W20220SPABG<br>—<br>MP-W20220LPABG |
| 6600 lbs, Short Drum, Manual Brake<br>6600 lbs, Short Drum, Auto Brake<br>6600 lbs, Long Drum, Manual Brake<br>6600 lbs, Long Drum, Auto Brake         | MP-W3036SACMB<br>MP-W3036SAAB<br>MP-W3036LACMB<br>MP-W3036LAAB     | —<br>MP-W3036SPAB<br>—<br>MP-W3036LPAB   | MP-W3036SACMBG<br>MP-W3036SAABG<br>MP-W3036LACMBG<br>MP-W3036LAABG     | —<br>MP-W3036SPABG<br>—<br>MP-W3036LPABG   |
| 11,000 lbs, Short Drum, Manual Brake<br>11,000 lbs, Short Drum, Auto Brake<br>11,000 lbs, Long Drum, Manual Brake<br>11,000 lbs, Long Drum, Auto Brake | MP-W5036SACMB<br>MP-W5036SAAB<br>MP-W5036LACMB<br>MP-W5036LAAB     | —<br>MP-W5036SPAB<br>—<br>MP-W5036LPAB   | MP-W5036SACMBG<br>MP-W5036SAABG<br>MP-W5036LACMBG<br>MP-W5036LAABG     | —<br>MP-W5036SPABG<br>—<br>MP-W5036LPABG   |
| 22,000 lbs, Standard Drum, Auto Brake  | MP-AH45-100-S1H  | MP-AH45-100-S1PH                         | MP-AH45-100-S1HG   | MP-AH45-100-S1PHG                          |

Pendant / Remote Control Retro-fit Kits Available.

## Exhaust Mufflers

| Part          | Size       | Fits Tool Model                      |
|---------------|------------|--------------------------------------|
| DM3-MFLRKIT   | 3/4" NPT   | MP-W05 Series                        |
| DM220-MFLRKIT | 1-1/2" NPT | MP-W10220 Series<br>MP-W20220 Series |
| DM36-MFLRKIT  | 1-1/2" NPT | MP-W3036 Series<br>MP-W5036 Series   |
| DM45-MFLRKIT  | 2" NPT     | MP-AH45 Series                       |



DM3-MFLRKIT



DM220-MFLRKIT



DM45-MFLRKIT

## Filter/Lubricator Kits

| Part         | Size       | Fits Tool Model  |
|--------------|------------|--|
| S14590-3/4   | 3/4" NPT   | MP-W05 Series  |
| S14590-1     | 1" NPT     | MP-W10220S Series<br>MP-W10220L Series<br>MP-W20220S Series<br>MP-W20220L Series |
| S14590-1 1/4 | 1-1/4" NPT | MP-W3036S Series<br>MP-W3036L Series<br>MP-W5036S Series<br>MP-W5036L Series     |
| S14590-2     | 2" NPT     | MP-AH45 Series   |



S14590-1



S14590-1 1/4



W05SSCMB



W20LSCAB



W50LSCAB

## Support Cages

| Part      | Drum/Brake    | Fits Tool Model  |
|-----------|---------------|--|
| W05SSCMB  | Short/Manual  | MP-W05 Manual Brake Series                                     |
| W05SSCAB  | Short/Auto    | MP-W05 Auto Brake Series                                       |
| W20SSCMB  | Short/Manual  | MP-W10220S Manual Brake Series, MP-W20220S Manual Brake Series |
| W20SSCAB  | Short/Auto    | MP-W10220S Auto Brake Series, MP-W20220S Auto Brake Series     |
| W20LSCMB  | Long/Manual   | MP-W10220L Manual Brake Series, MP-W20220L Manual Brake Series |
| W20LSCAB  | Long/Auto     | MP-W10220L Auto Brake Series, MP-W20220L Auto Brake Series     |
| W30SSCMB  | Short/Manual  | MP-W3036S Manual Brake Series                                  |
| W30SSCAB  | Short/Auto    | MP-W3036S Auto Brake Series                                    |
| W30LSCMB  | Long/Manual   | MP-W3036L Manual Brake Series                                  |
| W30LSCAB  | Long/Auto     | MP-W3036L Auto Brake Series                                    |
| W50SSCMB  | Short/Manual  | MP-W5036S Manual Brake Series                                  |
| W50SSCAB  | Short/Auto    | MP-W5036S Auto Brake Series                                    |
| W50LSCMB  | Long/Manual   | MP-W5036L Manual Brake Series                                  |
| W50LSCAB  | Long/Auto     | MP-W5036L Auto Brake Series                                    |
| AH45SSCAB | Standard/Auto | MP-AH45-100-S1H Series   |